

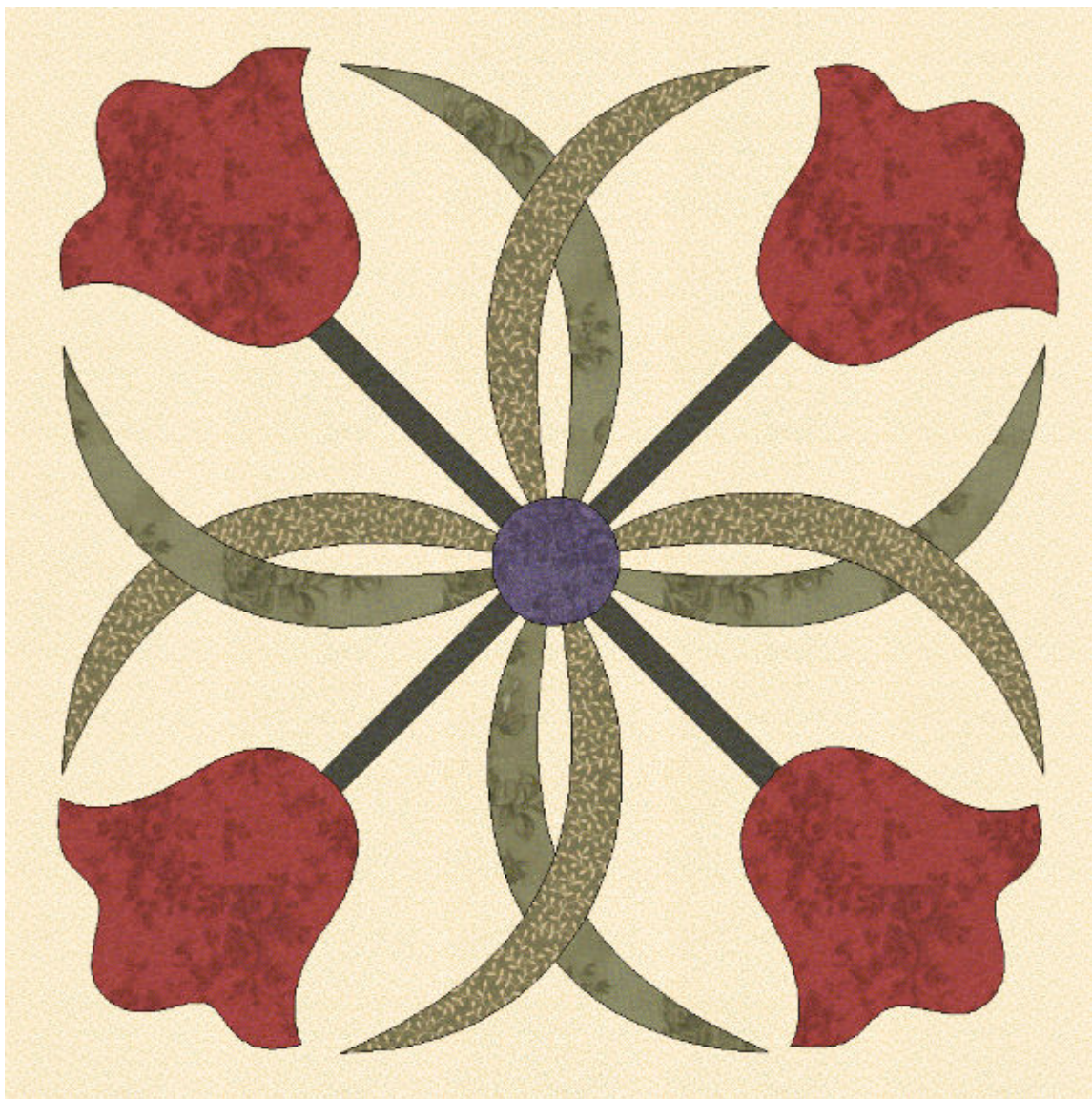





Appliqué Sampler Challenge
For the Members of the BlockCentral.com Quilting Forum

Block 5, August 2006
Dancing Tulips (Original Version)



Block size: 12" x 12"

Color Key

	Cream	Background; cut one 13" square and trim to 12-1/2" square after appliqué is complete.
	Light Green	Leaves J, K, N, P
	Medium Green	Leaves F, L, M, O
	Dark Green	Stems A, B
	Dark Pink	Tulips E, I, G, H
	Medium Blue	Circle D

Layout Guides

The letters in red identify each piece and correspond to the letters given in the Color Key.

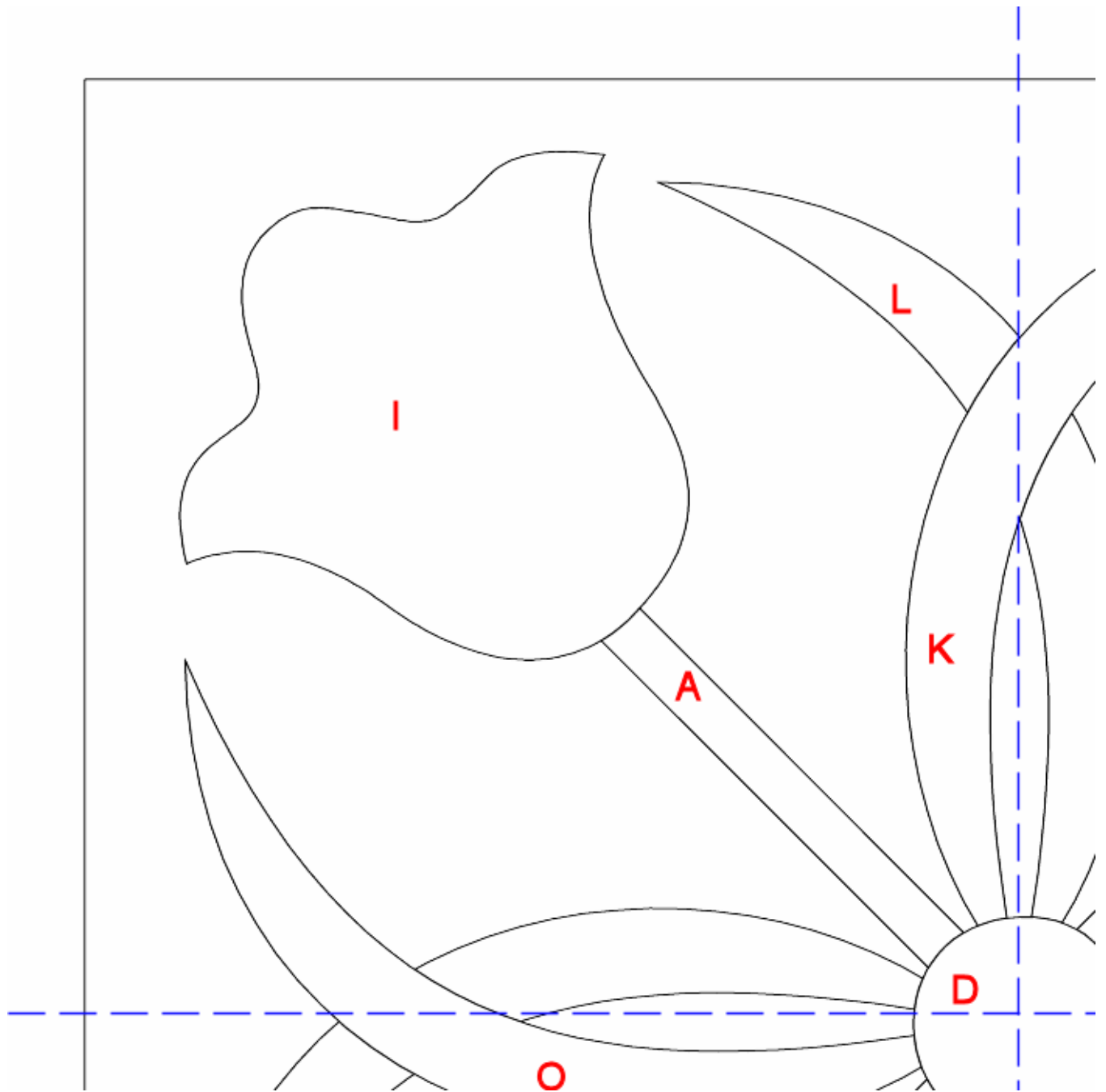

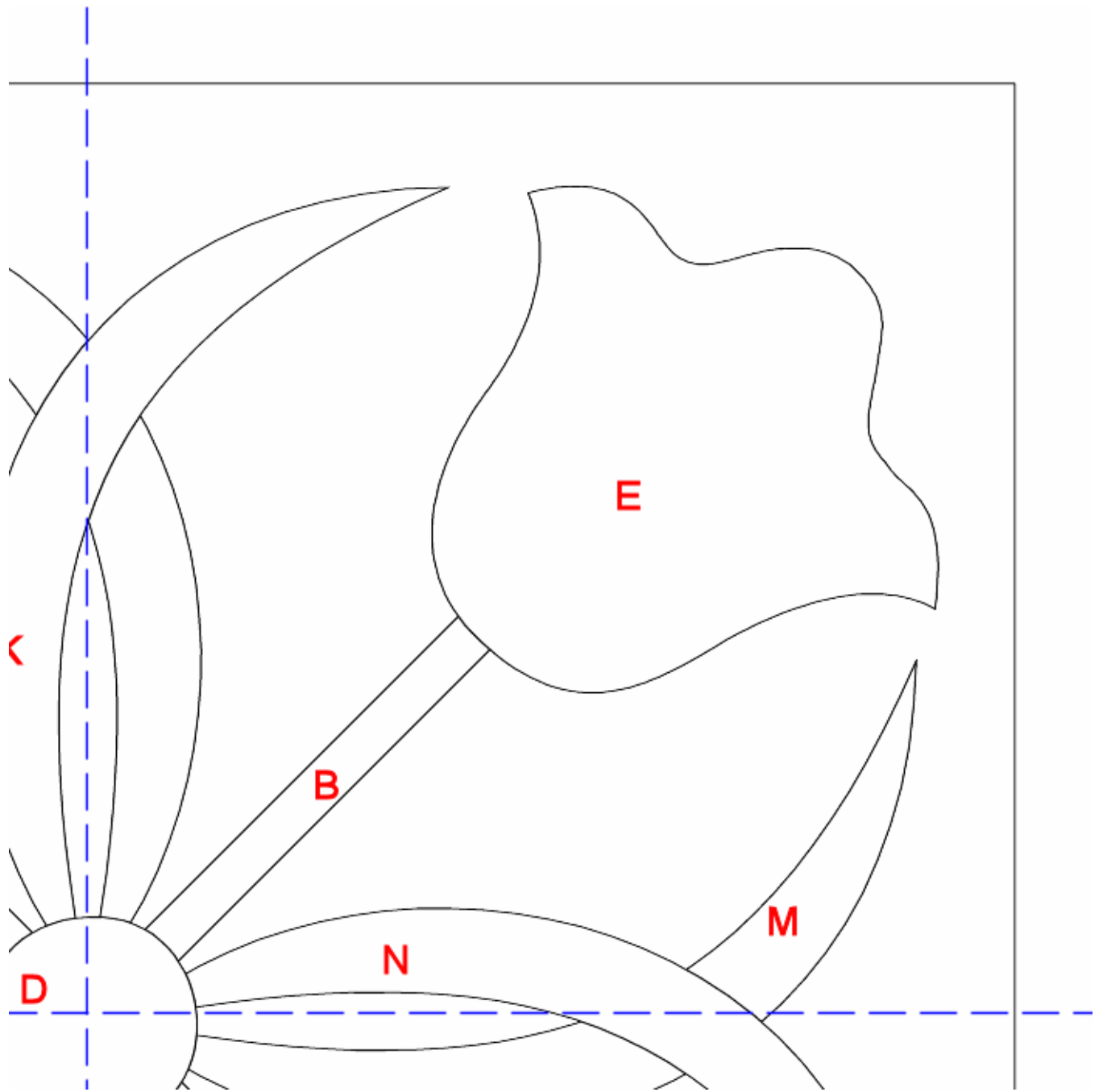

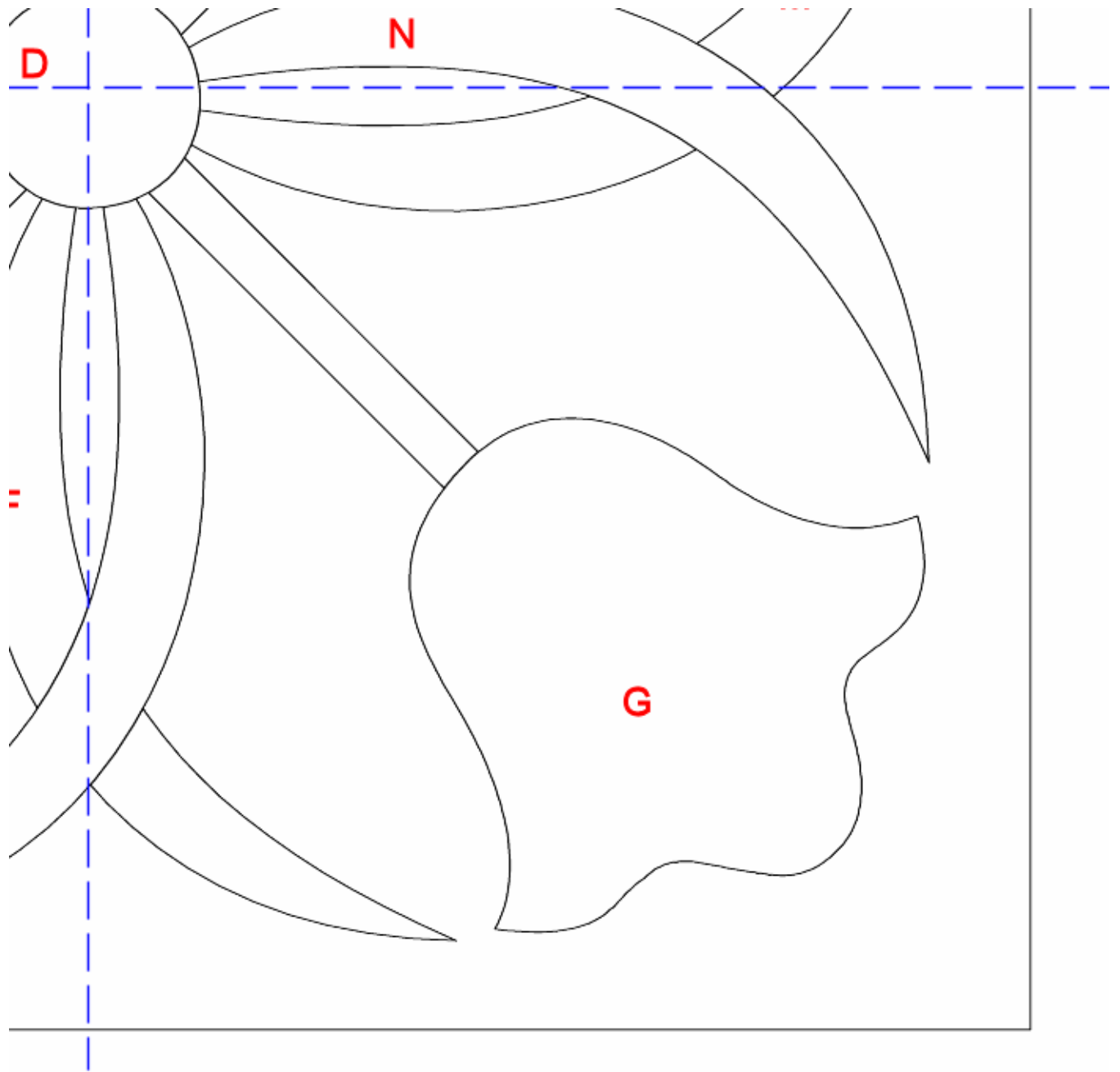

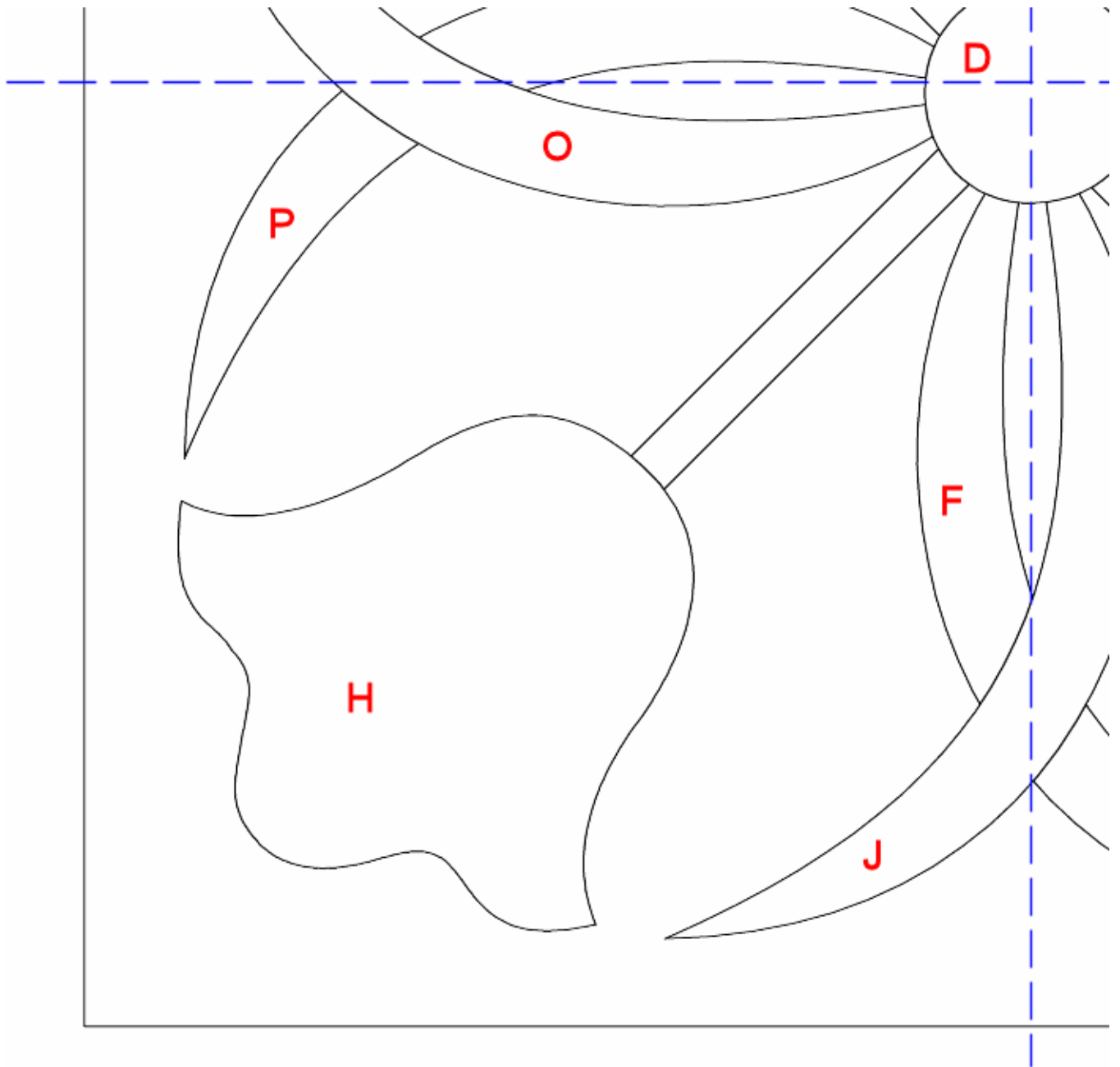

Templates

If you are using freezer paper on the back of your pieces or fusible appliqué, you'll need to print the templates on the following pages as mirror images. Look for a mirror option in your printer driver.

